

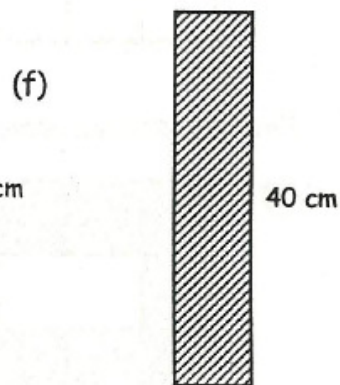

1. Calculate the area of each of the following rectangles.

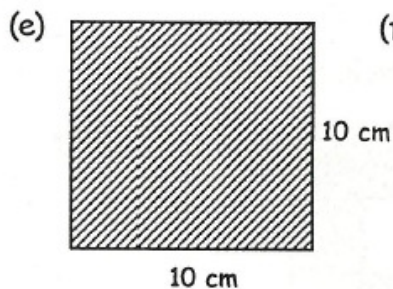

2. Find the area of each of the triangles :-

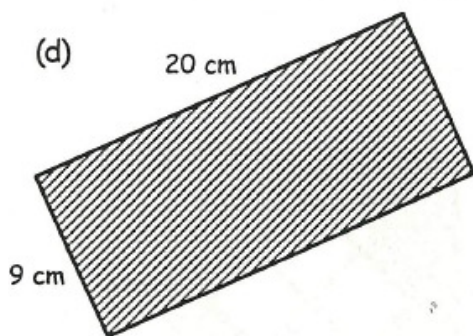
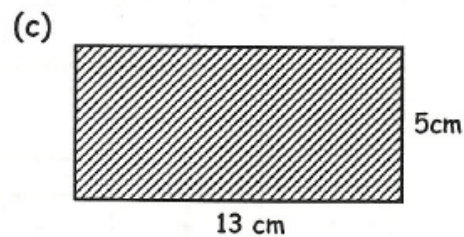
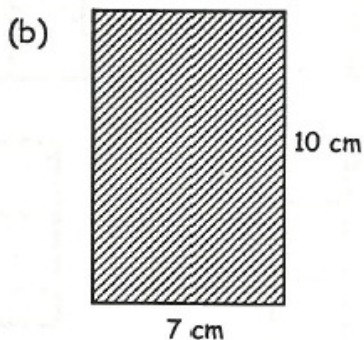
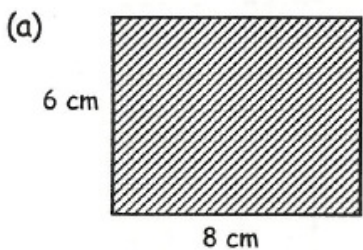
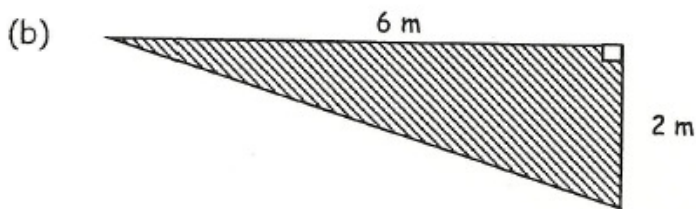
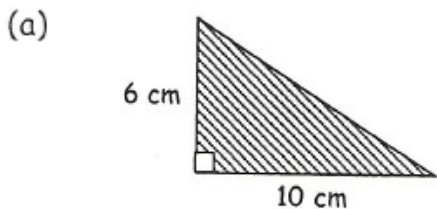

3. Calculate the total shaded area of each shape:

